

Mounting instructions for balance ball spin & tilt Ø500

Item No. 162500

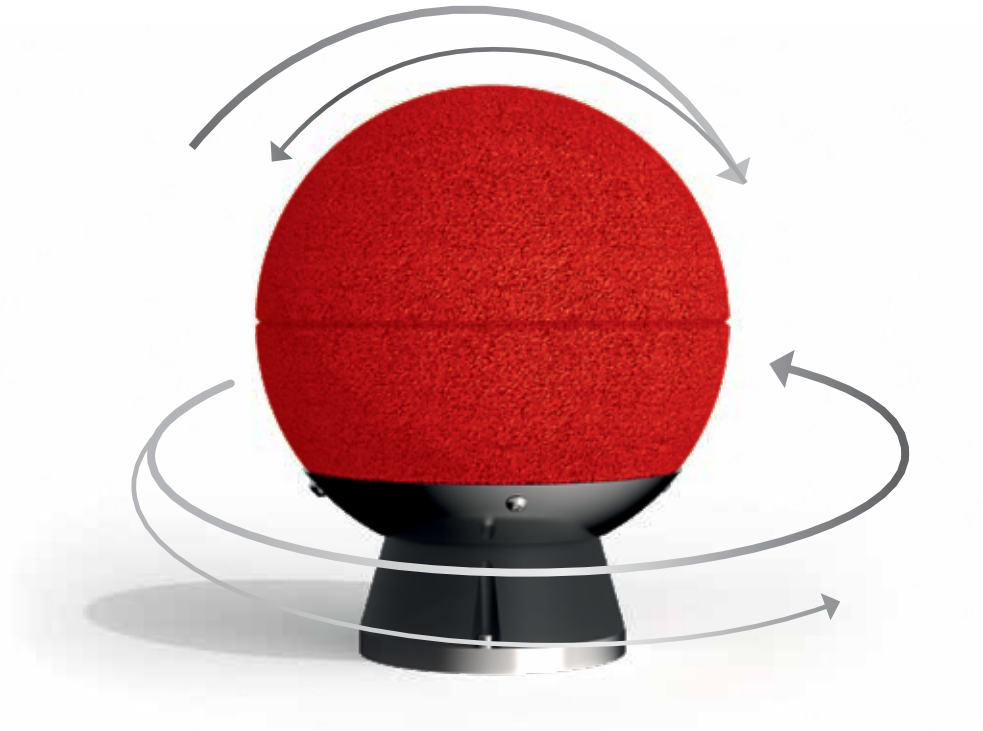
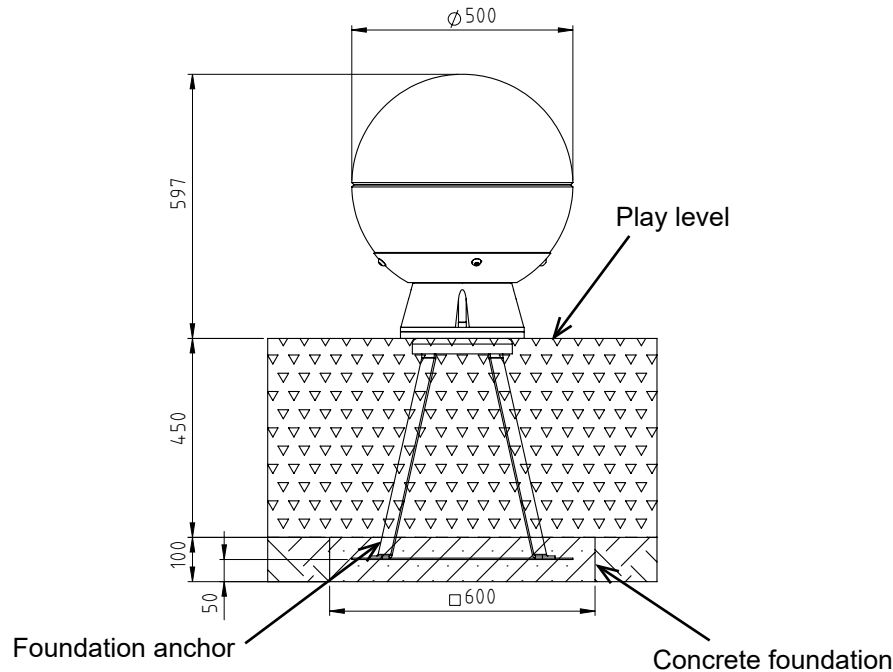

Diagram 1: Overall view of the play equipment

Mounting instructions for balance ball spin & tilt Ø500

Item No. 162500



1. Select the location of the play equipment taking into account the required minimum space (see diagram 3).
2. The impact area of a playground equipment with an enforced movement is not allowed to overlap the impact area of other equipment. According to DIN EN 1176-1, 4.2.8.5.2 shock-absorbing floors must be made on the entire impact area of every equipment that cause forced movement.
3. Carry out excavation work for the foundation as shown in diagram 2. After excavation compress the foundation floor.
Note: The play equipment is installed at play level.
4. Place the play equipment with foundation anchor as shown in diagram 2 in the foundation hole.

Reinforcement plan: Concrete foundation with reinforcement

Main foundation: BSt 500S

Stirrups Ø 8 mm lengthwise and cross

Concrete cover $h' = 3$ cm

Concrete quality class C20/25

5. Place the play equipment with foundation anchor into the concrete mass as shown in diagram 2, so that the base plate is surrounded by a concrete thickness of at least 50 mm both above and below.
6. Pour the foundation floor with concrete to a height of approx. 100 mm.

Legende





-  stoßdämpfender Boden
shock-absorbing floor
-  beliebiger Boden
optional floor
-  Beton
concrete
-  gewachsenes Erdreich
natural ground

Diagram 2: Foundation plan

Mounting instructions for balance ball spin & tilt Ø500

Item No. 162500

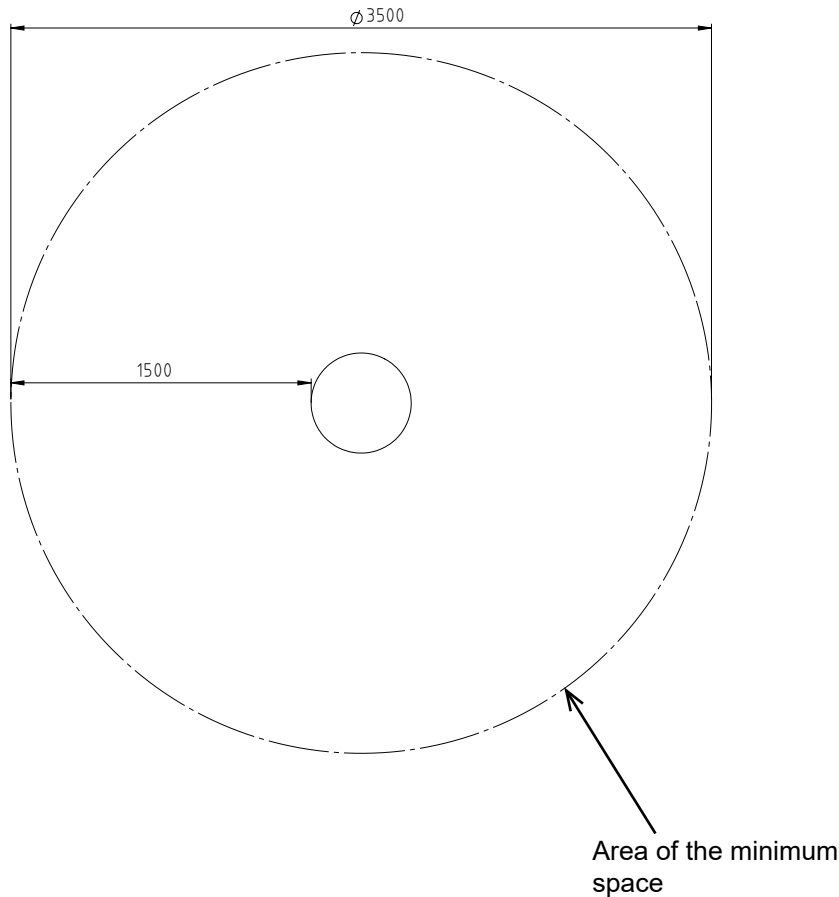

Diagram 3: Top view

7. After a setting period of 10 - 14 days, depending on weather conditions and foundation size, cover the entire impact area with fall protection according to the required drop height in accordance with EN 1176-1.

Critical drop height: 600 mm

Recommended surface material: grass, sand, wood chip, gravel, synth. impact protection.

8. Do not allow children to use the equipment before the installation has been finished.

Attention: If the play equipment has been incompletely installed or partly dismantled when carrying out maintenance and repair work, this may lead to particular risks of injury for the user. For this reason, make clearly visible that the equipment shall not be used in such cases.

NOTE: Play equipment, which contain components made of stainless steel should not come with „normal“ steel parts in contact. Those steel parts may rub off and leave small steel particles in combination with moisture brown rust stains. If such corrosion occur on stainless steel parts, they are fine with an abrasive (240 grit) to remove.

Please take care when transporting and setting up the fact that the components are made of stainless steel with no „normal“ steel parts in contact.

Mounting instructions for balance ball spin & tilt Ø500

Item No. 162500

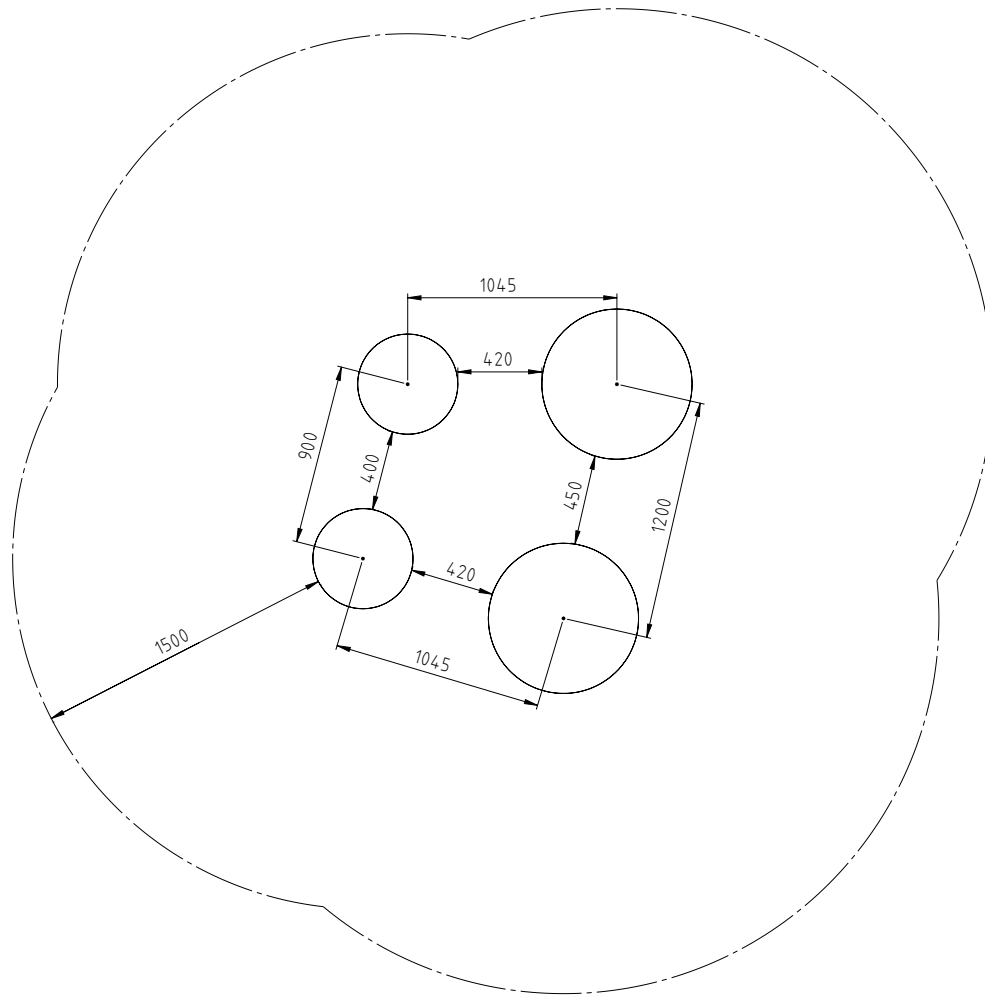

Diagram 4: Possibility of installation

In order to preserve a good visual appearance of your playground equipment over a long period one should take care of maintenance of the stainless surface even despite of their corrosion resistance.

Especially areas, which can not be reached by rainfall should be frequently cleaned from dirt and deposits due to air pollution and dirt caused by the atmosphere. Light soiling can easily be removed by using a high pressure cleaner.

For persistent deposits use a clean cloth moistened with a special liquid cleaner (e.g. on phosphoric acid) and rinse off with clear water after a short application time. During cleaning with mild abrasive components, only wipe over stainless steel surface in polishing direction.

For heavily soiled surfaces, polishes can be used (e.g. for cleaning chrome on cars) or for greasy and oily dirt alcoholic cleaning agents and solvents (e.g. ethyl alcohol, isopropyl alcohol or acetone).

However, it should be noted that the dissolved soiling is not spread over the surface again.

Do not use any chlorid or hydrochloric containing cleaning products nor scouring powder, bleaching - or silver polish cleaner. Cleaning intervals depend on type and degree of soiling as well as on demands made on optical characteristics.

Therefore cleaning is advisable at intervals of six to twelve months – whereby in the case of strong soiling it is appropriate to clean the playground equipment at intervals of three to six months.